

PRODUCT DATASHEET

PANEL 600 36 W 4000 K OP WT

PANEL PFM HO 600 | Square recessed panel luminaires with high luminous flux, 600 x 600 mm

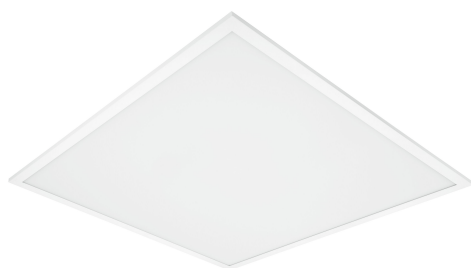

Areas of application

- Direct replacement for luminaires with fluorescent lamps
- Corridors
- Offices
- Conference rooms
- Reception areas
- Foyers
- Elevators
- Suitable for recessed ceiling systems with grid size of 600 x 600 mm

Product benefits

- High lumen output reduces the total number of panels per installation
- Light guide plate with micro structure made of non-yellowing material for long lifetime
- Low flicker light thanks to special electronic control gear
- Energy savings of up to 50 % (compared to luminaires that use fluorescent lamps)
- 5 years guarantee

Product features

- Luminous flux: up to 4,320 lm
- High luminous efficacy: up to 120 lm/W
- Lifetime (L80/B50): up to 60,000 h (at 25 °C)
- Aluminum housing, polystyrene diffuser



TECHNICAL DATA

Electrical data

Nominal wattage	36.00 W
Nominal voltage	220...240 V
Mains frequency	50...60 Hz
Nominal current	190.000 mA
Inrush current	15.0 A
Max. number of luminaires per miniature circuit breaker B16	17
Max. number of luminaires per miniature circuit breaker C10	35
Max. number of luminaires per miniature circuit breaker C16	56
Power factor λ	> 0.95
Total harmonic distortion	\leq 20 %
Protection class	II
Operating mode	External LED driver

Photometrical data

Luminous flux	4320 lm
Luminous efficacy	120 lm/W
Color temperature	4000 K
Light color (designation)	Cool White
Color rendering index Ra	> 80
Standard deviation of color matching	3 sdc _m
Low flicker	Yes
Photobiological safety group acc. to EN62778	RG0
Beam angle	120 °

0.5	1.54 1.51	E(0°) 5875 E(C90) 476 E(C0) 499
1.0	3.08 3.01	E(0°) 1469 E(C90) 119 E(C0) 125
1.5	4.62 4.52	E(0°) 653 E(C90) 53 E(C0) 55
2.0	6.16 6.02	E(0°) 367 E(C90) 30 E(C0) 31
2.5	7.70 7.53	E(0°) 235 E(C90) 19 E(C0) 20
3.0	9.24 9.03	E(0°) 163 E(C90) 13 E(C0) 14

Distance [m] Cone diameter [m] Illuminance [lx]

— C0/C180 (Half beam angle [°]: 112.8°)
— C90/C270 (Half beam angle [°]: 114.0°)

Panel 600 36W 4000K OP

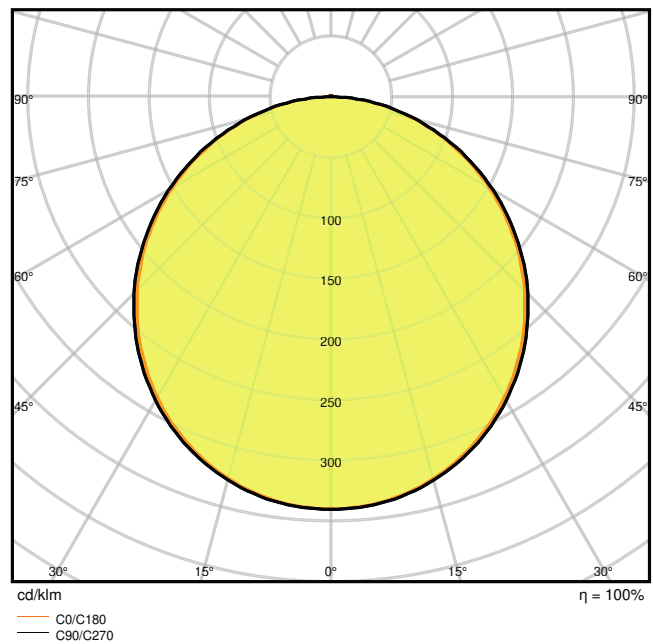

Panel 600 36W 4000K OP

Dimensions & Weight

Length	595.00 mm
Width	595.00 mm
Height	12.20 mm
Product weight	3250.00 g

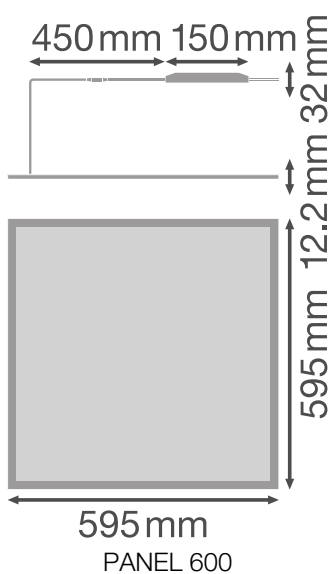

Materials & Colors

Product color	White
Housing color	White
Body material	Steel
Cover material	Polystyrene (PS)
Light emitting surface material	Polystyrene
Glow Wire Test according to IEC 60695-2-12	650 °C
Mercury content	0.0 mg

Application & Mounting

Ambient temperature range	-10...+40 °C
Type of connection	Screw terminal, 2-Pole (L,N)
Type of protection	IP20
Protection class IK (shock resistance)	IK03
Dimmable	No
Mounting type	Recessed/Suspended/Surface
Mounting location	Ceiling / Wall
Application environment	Indoor
Mounting length	575 mm
Mounting width	575 mm
Mounting depth	50,0 mm
Replaceable light source	No

Lifespan

Lifespan L70/B50 at 25 °C	80000 h ¹⁾
Lifespan L80/B10 at 25 °C	60000 h ¹⁾
Lifespan L80/B50 at 25 °C	60000 h
Lifespan L90/B10 at 25 °C	35000 h
Number of switching cycles	25000

¹⁾ t[h]: L70 / B50 @ 25 °C (Ta), t[h]: L80 / B10 @ 25 °C (Ta), t[h]: L90 / B10 @ 25 °C (Ta)

Control gear







ECG - Length	150 mm
ECG - Width	41,4 mm

ECG - Height	32 mm
--------------	-------

Certificates & Standards

Standards	CE / CB / ENEC / TÜV SÜD / EAC / RoHS
Ball shot safe	No
Replaceable light source (EPREL)	Not replaceable

Accessories Optional





Product image	Product name	EAN
	PANEL 600 SURFACE MOUNT KIT H70 VAL	4058075402843
	PANEL 600 RECESSED MOUNT FRAME	4058075402881
	PANEL Suspension Kit	4058075402928
	PANEL 600 SURFACE MOUNT KIT H75	4058075472914
	EM CONVERSION BOX	4058075237025
	PANEL RECESSED MOUNT CLIPS VAL 4x	4058075409859
	CONNECTOR BOX 5POLE L/N/PE/D+/D- 4x	4058075473034





Product image	Product name	EAN
	CONNECTOR BOX 5POLE L/N 4x	4058075473010

EQUIPMENT / ACCESSORIES

- Accessories for several mounting options available
- Security rope for luminaire included
- External control gear included
- Not suitable for use with Emergency Conversion Box

DOWNLOAD DATA

Documents and certificates	Document name
 User instruction / safety instructions	PANEL 600 / 625
 Declarations of conformity	Declaration of Conformity Panel 600 625 MP OP LEDV
 Declarations of conformity	Attestation-of-Conformity-Panel MP OP IP20 TÜV
 Certificates	ENEC Panel 600 625

Photometric and lighting design files	Document name
 IES file (IES)	Panel 600 36W 4000K OP
 LDT file (Eulumdat)	Panel 600 36W 4000K OP
 UGR file (UGR table)	Panel 600 36W 4000K OP
 Light distribution curve type cone	Panel 600 36W 4000K OP
 Light distribution curve type polar	Panel 600 36W 4000K OP

LOGISTICAL DATA

Product code	Packaging unit (Pieces/Unit)	Dimensions (length x width x height)	Gross weight	Volume
4058075113084	Folding box 1	625 mm x 38 mm x 680 mm	3545.00 g	16.15 dm ³

Product code	Packaging unit (Pieces/Unit)	Dimensions (length x width x height)	Gross weight	Volume
4058075113091	Shipping box 4	695 mm x 170 mm x 645 mm	15030.00 g	76.21 dm ³

The mentioned product code describes the smallest quantity unit which can be ordered. One shipping unit can contain one or more single products. When placing an order, for the quantity please enter single or multiples of a shipping unit.

ADDITIONAL CATALOG INFORMATION

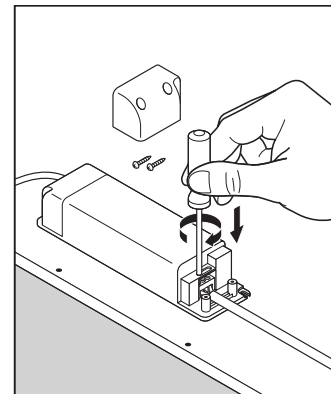
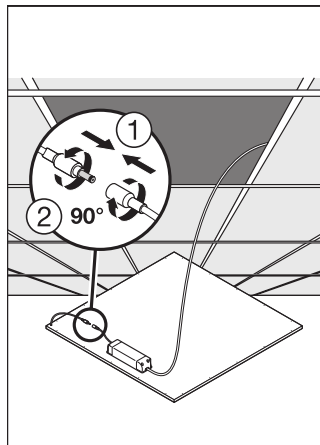
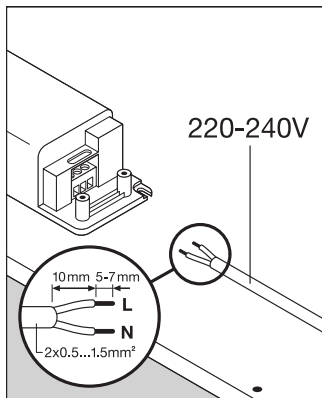

References / Links

– For Guarantee see www.ledvance.com/guarantee

DISCLAIMER

Subject to change without notice. Errors and omission excepted. Always make sure to use the most recent release.